



US00D906038S

(12) **United States Design Patent** (10) **Patent No.:** **US D906,038 S**
Pin (45) **Date of Patent:** **** Dec. 29, 2020**

(54) **STRAW HOLDER WITH STRAP**
(71) Applicant: **Webb Business Promotions, Inc.**,
Eagan, MN (US)

6,485,379 B2 11/2002 Fondin et al.
6,641,390 B2 11/2003 Genuise
6,644,613 B2 11/2003 Grosskopf
(Continued)

(72) Inventor: **He Zhao Pin**, Dongguan (CN)

FOREIGN PATENT DOCUMENTS

(73) Assignee: **Webb Business Promotions, Inc.**,
Eagan, MN (US)

FR 333255 11/1903
FR 2858927 A1 2/2005
(Continued)

(**) Term: **15 Years**

OTHER PUBLICATIONS

(21) Appl. No.: **29/685,497**

Haotian Silicone Technology Co., Ltd., "Animal Silicon Handwash Bottle Holder", "Available from Internet URL: <https://www.ht-silicone.com/product/details/id/99.html>", , Publisher: Examiner in related U.S. Appl. No. 29/684,060 visited site [Jun. 16, 2019].
(Continued)

(22) Filed: **Mar. 28, 2019**

(51) **LOC (12) Cl.** **07-01**

(52) **U.S. Cl.**
USPC **D7/387; D7/300.2; D7/213**

(58) **Field of Classification Search**
USPC D7/505, 213, 300.2, 396.2, 387;
D3/203.1, 274; D24/224
CPC A45F 5/02; A47G 19/22
See application file for complete search history.

Primary Examiner — Marianne N Pandozzi
(74) *Attorney, Agent, or Firm* — Charles A. Lemaire;
Jonathan M. Rixen; Lemaire Patent Law Firm, P.L.L.C.

(57) **CLAIM**

The ornamental design for a straw holder with strap, as shown and described.

(56) **References Cited**

U.S. PATENT DOCUMENTS

370,004 A	9/1887	Bruner	
730,218 A	6/1903	Anderson	
1,420,297 A *	6/1922	Thompson A47G 19/2222 215/391
1,633,197 A	6/1927	Snyder	
D193,121 S	6/1962	Wickman	
D206,294 S	11/1966	Poris	
3,434,620 A	3/1969	Laurizio	
D320,136 S *	9/1991	Adcock D7/300.2
D354,158 S	1/1995	Trudeau	
5,379,928 A	1/1995	Mikkelsen	
5,573,152 A	11/1996	Arnold	
5,806,730 A	9/1998	Deno	
5,992,715 A	11/1999	Habibi	
D438,626 S	3/2001	Broussard	
6,216,319 B1	4/2001	Elkins	

DESCRIPTION

FIG. 1 is a perspective view of the decorative straw holder with strap showing the new design;
FIG. 2 is a top view thereof;
FIG. 3 is a bottom view thereof;
FIG. 4 is a right-side view thereof;
FIG. 5 is a left-side view thereof;
FIG. 6 is a front view thereof; and,
FIG. 7 is a back view thereof.
The broken lines in FIGS. 1-7 are for the purpose of illustrating portions of the straw holder with strap that are not part of the claimed design.

1 Claim, 2 Drawing Sheets

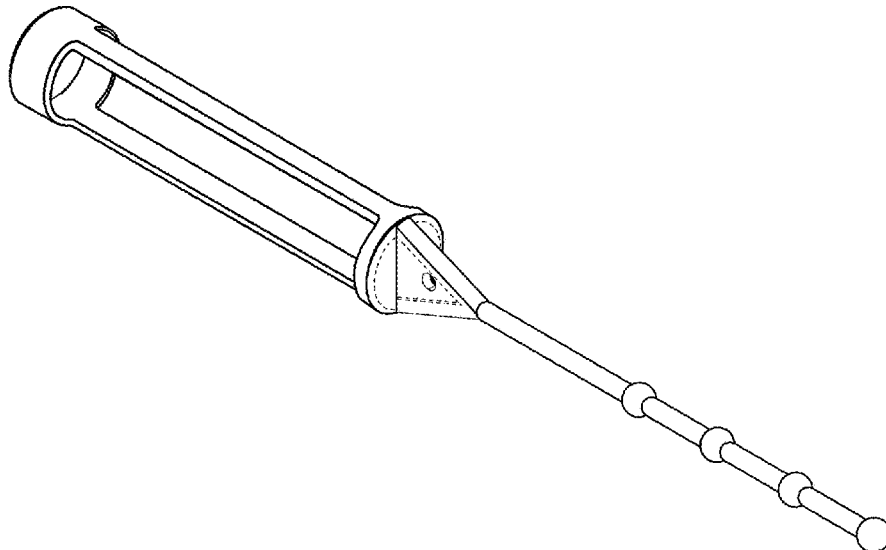

(56)

References Cited

U.S. PATENT DOCUMENTS

D512,910 S 12/2005 Haslam
 6,978,918 B2 12/2005 Scanlan et al.
 7,387,225 B2 6/2008 Fox
 D594,605 S 6/2009 DeLuco
 D597,788 S 8/2009 Ellis
 D643,722 S 8/2011 Gorskey
 D676,318 S 2/2013 MacNeill
 D682,017 S 5/2013 Smiedt
 8,464,896 B2* 6/2013 Beary A47G 19/2222
 220/708
 D691,365 S * 10/2013 Cote D3/203.2
 D722,726 S 2/2015 Reukema
 D745,743 S * 12/2015 Reukema D29/101.1
 D747,198 S 1/2016 Biswas
 D753,998 S 4/2016 Murphey
 D760,490 S * 7/2016 Johnson D3/203.1
 D764,787 S * 8/2016 Montminy D3/202
 D776,488 S 1/2017 Brashears
 D776,533 S 1/2017 Kikel
 D790,913 S * 7/2017 Stover D7/396.2
 D797,555 S 9/2017 Carlson
 D798,105 S * 9/2017 Stover D7/396.2
 9,918,530 B2 3/2018 Bouganinn
 D838,167 S 1/2019 Lopynski
 10,188,186 B2 1/2019 Norman
 D839,730 S 2/2019 Wang
 D840,145 S * 2/2019 Lucciola D3/203.1
 D847,568 S * 5/2019 Hartnett D7/505
 D853,193 S * 7/2019 Hartnett D7/505
 D888,483 S * 6/2020 Lin D7/300.2
 2005/0199512 A1* 9/2005 Davidson A45F 5/02
 206/37

2006/0096987 A1 5/2006 Wry
 2008/0061091 A1 3/2008 Mailliard
 2010/0096398 A1 4/2010 Gorskey
 2014/0166610 A1 6/2014 Paterson

FOREIGN PATENT DOCUMENTS

FR 2965706 A1 4/2012
 JP 2004105420 4/2004
 WO WO_2015030936 3/2015

OTHER PUBLICATIONS

“Bottle Band”, “https://www.amazon.com/Bottle-Band-Cirrus-Fitness-BottleBand/dp/BOOUE64ZRE/ref=cm_cr_ar_p_d_product_top?ie=UTF8”, , Publisher: Announced Aug. 16, 2015 [online].
 Industrial Amphenol, “Pin Receptacle”, “Available from Internet URL: <https://www.amphenol-sine.com/AHDC169-T-OBDDGN-HD-Series-9-Pin-Receptacle-Cap-w-Rubber-Tether-OBD-GREEN-p6410.html>”, , Publisher: Examiner in related U.S. Appl. No. 29/684,060 visited site [Jun. 16, 2019].
 Webb Companies, “Silicone Carabiner”, “from Internet URL: <https://web.archive.org/web/20190126084924/http://www.webbcompany.com/product-detail/Silicone-Carabiner-Metallic-Lip-Balnn/626>”, , Publisher: Announced Jan. 26, 2019 [online].
 Webb Companies, “Hand Sanitizer with Removable Silicone Carabiner”, “Downloaded from web address: <http://www.webbcompany.com/product-detail/1oz-Hand-Sanitizer-with-Removable-Silicone-Carabiner/115>”, 2015 earliest known.
 Webb Companies, “Silicone Caribiner”, , Publisher: Downloaded Feb. 9, 2018, from internet URL: <http://www.webbcompany.com/product-detail/>.

* cited by examiner

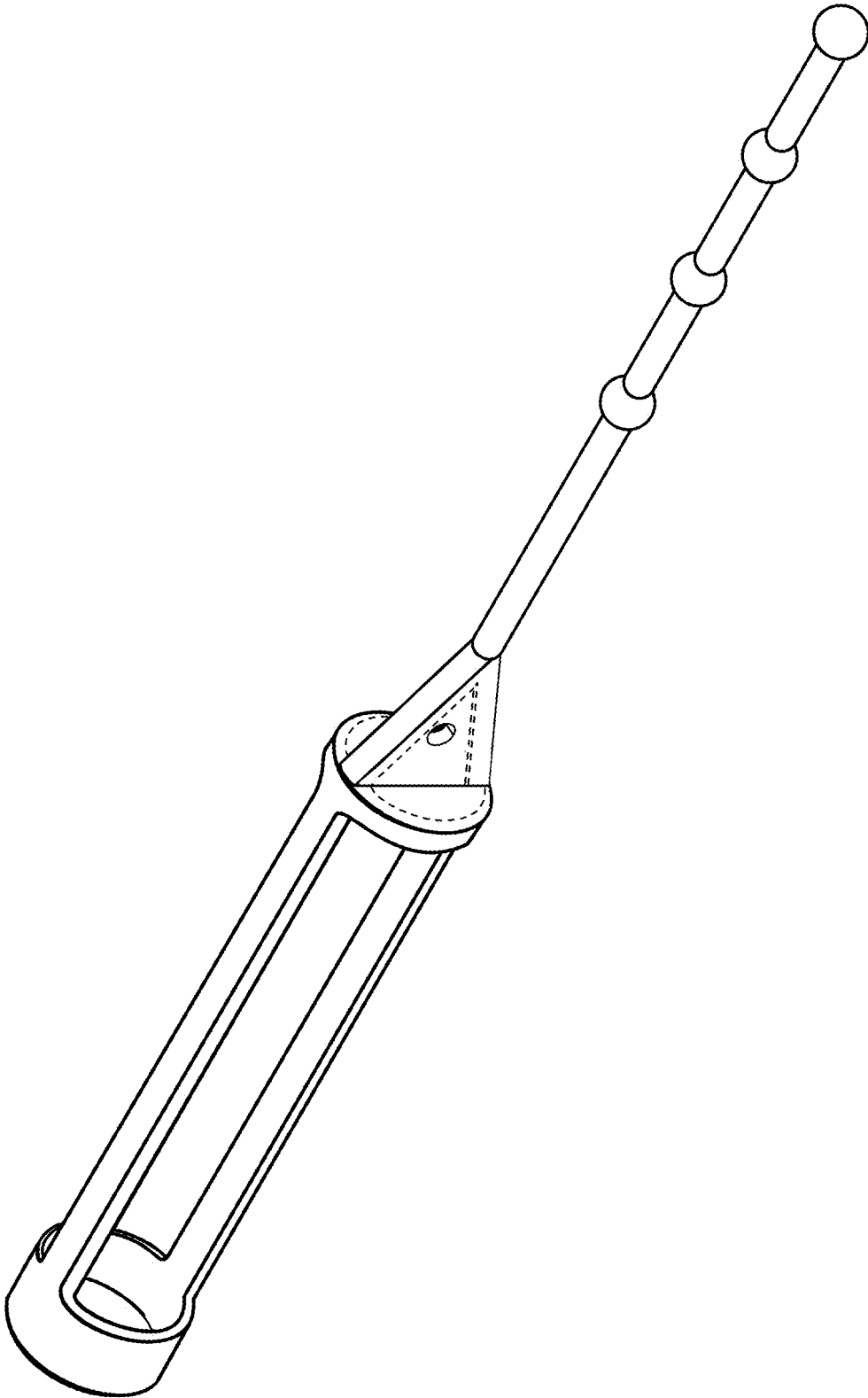

FIG. 1

FIG. 2

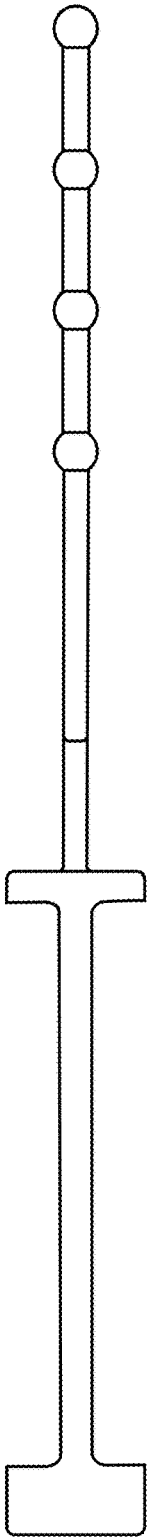

FIG. 3

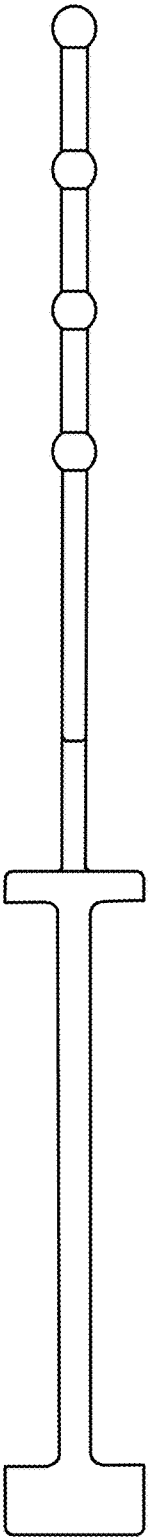

FIG. 4

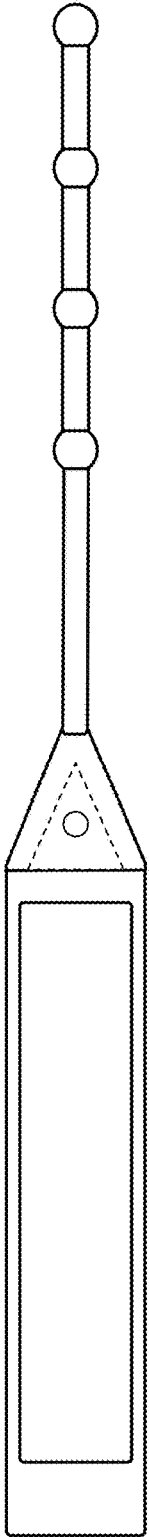

FIG. 5

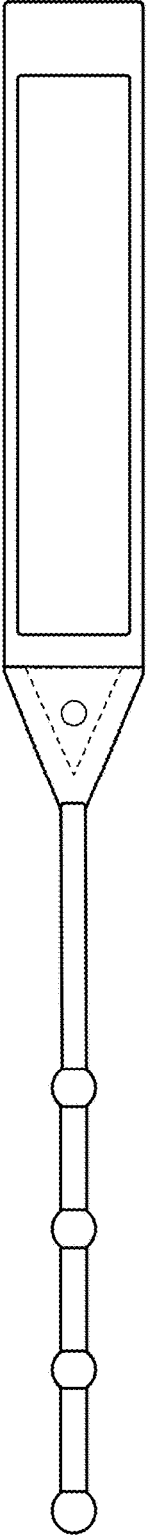

FIG. 6

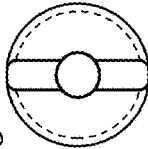

FIG. 7

